

S-Sight

This series simplifies surveillance with high-quality images and enhanced night vision capabilities. Powered by AI (DDA™ Video Analytics and Face Recognition) and equipped with Check Point protection for comprehensive monitoring. Choose from rainbow cameras, Motorized Varifocal options, and Anti-Vandal designs for high-security areas.



DV-340SRN-28

4MP 24/7 Full-Color Fixed Lens Small Dome/Turret Camera

The S-Sight rainbow camera series is equipped with super light-sensitive sensors that allow the camera to provide a color image throughout the day. When the ambient light is insufficient, the camera will turn on the integral lighting, allowing it to continue providing a full-color image. The camera also offers outstanding DDA Analytics (Detect, Distinguish, Alert), which can perform human and vehicle recognition. With its outstanding performance, reliability, and affordable price, the DV-340SRN-28 camera is the perfect solution for indoor/outdoor installations.

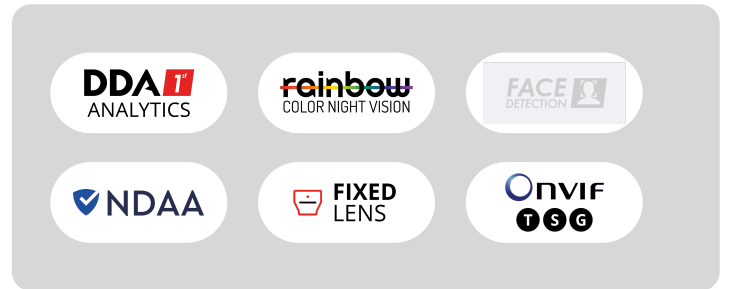

MAIN FEATURES

- DV-340SRN-28
- Sensor: 1/3" CMOS (16:9)
- Resolution: 2560×1440 25/30FPS (4MP)
- Lens: 2.8mm (99°) 24/7 Full-Color Day Mode
- Illumination: 25m (2 High-Power White LED)
- Compression: H.265+/ H.264+ / H.265 / H.264 / MJPEG
- General Analytics: Camera Tampering
- AI (Object Recognition): DDA Sterile Area, DDA Line Crossing
- True WDR (120dB), BLC, HLC, ROI
- SD Card: Event/Schedule Record (Up to 256Gb)
- Built-in Microphone + Audio input
- ONVIF: Profile T/S/G
- Water Proof: IP67
- Weight: ~450g
- Power: DC12V/~460mA / PoE/~5.5W



<https://provision-isr.com>

SPECIFICATIONS

3rd Party Cyber Protection	
General	N/A
Protection Methods	N/A
NDAA Compliant	
NDAA Compliant	Yes
Video	
Image Sensor	1/3" CMOS (16:9)
Effective Pixels	2560x1440
Electronic Shutter	1s ~ 1/1000000s
Day & Night	24/7 Full-Color Day Mode
Min. Illumination	0.003lux (@F1.0, AGC on) 0lux with LED on
Audio	
Audio compression	G.711A/G.711U
Communication	One-Way Audio
Image	
Image Settings	AWB, AGC Adjustable, Exposure Mode (Auto) Sharpness, Saturation, Brightness & Contrast Adjustable
Image Enhancement	True WDR (120dB), BLC, HLC, ROI
Noise Reduction	3D-DNR
Image Orientation	Mirror/Flip, Corridor Mode
Privacy Zone	Yes
Events and Analytics	
Analytics	General Analytics: Camera Tampering AI (Object Recognition); DDA Sterile Area, DDA Line Crossing
Motion Detection	Yes
Compression	

Resolution	4MP (2560x1440) / 3MP (2304x1296) / 2MP (1920x1080) / D1 / QVGA / CIF
Frame Rate	1-25/30FPS
Video Compression	H.265+ / H.264+ / H.265 / H.264 / MJPEG**
Multi-Stream	Master Stream: 4MP (2560x1440) / 3MP (2304x1296) / 2MP (1~30fps) Substream: 1MP (1~12/15fps) / D1/CIF (1~30fps) Third Stream: D1/CIF (1~30fps)
Bit Rate	64Kbps ~ 5Mbps@H.265 / 64Kbps ~ 5Mbps@H.264
Encode Mode	VBR/CBR
Image Quality	Five levels under VBR; Free adjustment under CBR

Lens	
Lens (Field of View)	2.8mm (99°)
Iris	Fixed Iris
Lens Mount	M12 Mount
Detect	57.76m(189.50ft)
Recognize	11.55m(37.89ft)
Identify	5.78m(18.96ft)

Network	
User Access	Supports simultaneous monitoring of up to 3 users with multi-stream real-time transmission
Network Protocol	IPv4, IPv6, TCP, UDP, DHCP, NTP, DDNS, 802.1X, RTSP, Multicast, UPnP, Email, FTP, HTTPS, QoS, P2P
Remote Monitoring	IE Browsing (Plug-In required), Chrome/Edge/Safari/Firefox plug-in free browsing, Ossia VMS Software, Provision Cam2 Mobile App
Ethernet	100Mbps
ONVIF	Profile T/S/G

Connectivity	
Network	RJ45 (+PoE)
Audio Connectivity	Built-in Microphone + Audio input

Alarm	No
SD Card	Event/Schedule based Main/Substream recording (Up to 256Gb)
Wiegand	No
Power	DC Socket
Analog Video Output	No

Housing	
PoE	Yes
Illumination	25m (2 High-Power White LED)
Power Supply	DC12V/~460mA / PoE/~5.5W
Protection Rate	Water Proof: IP67
Work Environment	-30°C~60°C, 10%~90% Humidity
Bracket	3-Axis Bracket
Dimensions	Ø97mm×82.6mm
Weight (gross)	~450g
Hard Reset Button	Yes

DIMENSIONS

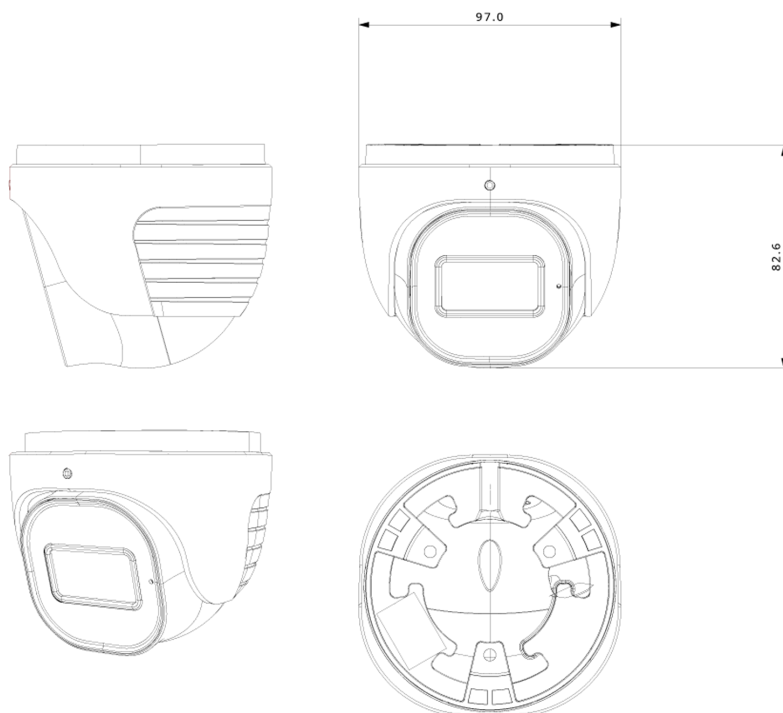

ACCESSORIES

